



# Pianificazione dei tornei

Per una descrizione dettagliata degli schemi rimandiamo al fascicolo «Forme di tornei».

Ordinazione:

Ufficio federale dello sport UFSPPO

Documentazione G+S

2532 Macolin

E-mail: [dok.js@baspo.admin.ch](mailto:dok.js@baspo.admin.ch)

## Altre informazioni

Per ulteriori informazioni puoi rivolgerti alle federazioni sportive riportate di seguito:

**swiss badminton**

[www.swissbadminton.ch](http://www.swissbadminton.ch)

**SWISS SQUASH**

[www.squash.ch](http://www.squash.ch)

**Swiss Tennis**

[www.myTennis.ch](http://www.myTennis.ch)

**Federazione svizzera di tennistavolo**

[www.sttv.ch](http://www.sttv.ch)





## Torneo ad eliminazione

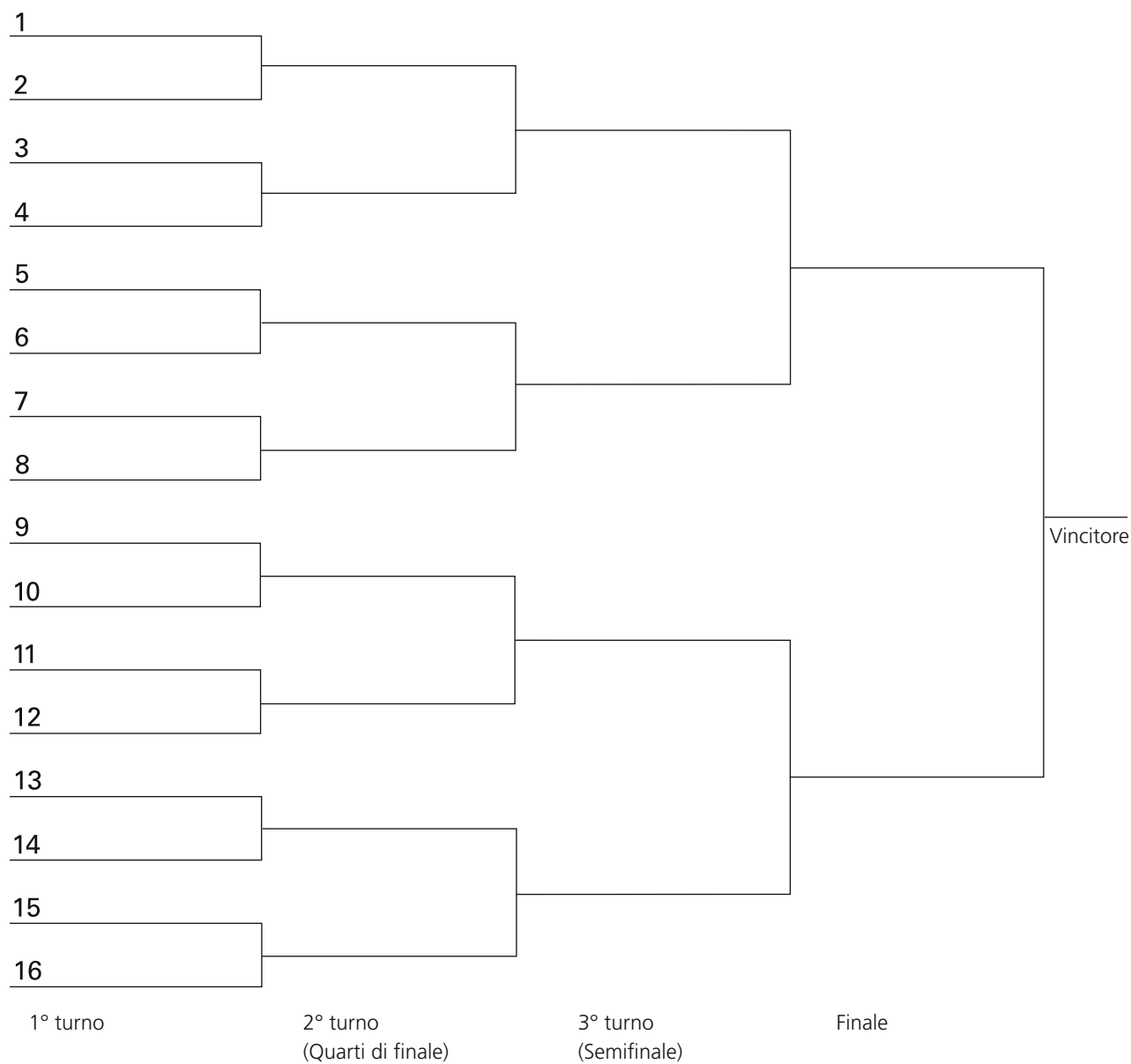



## Torneo ad eliminazione

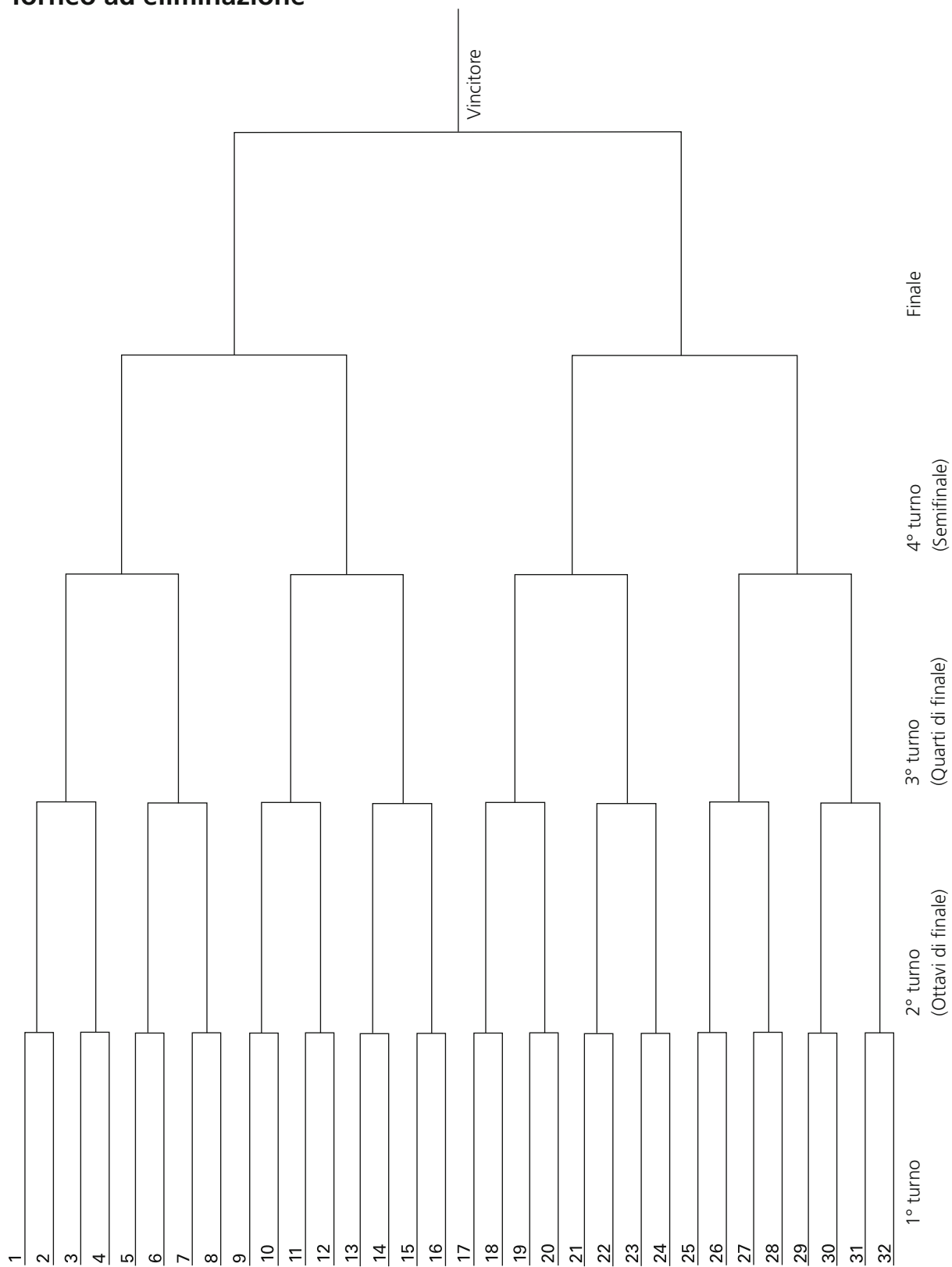



## Torneo a doppia eliminazione

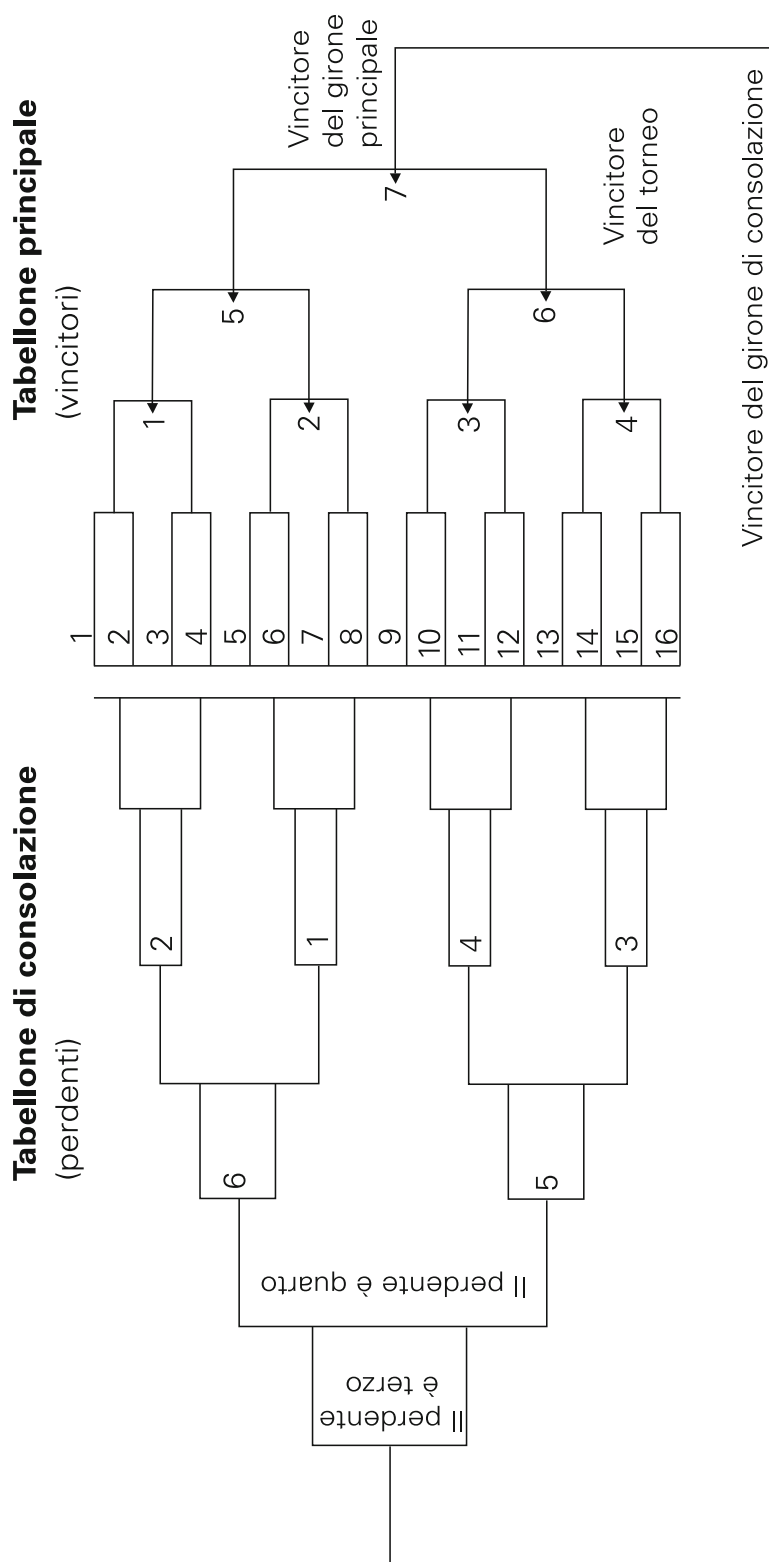





## Torneo con classifica

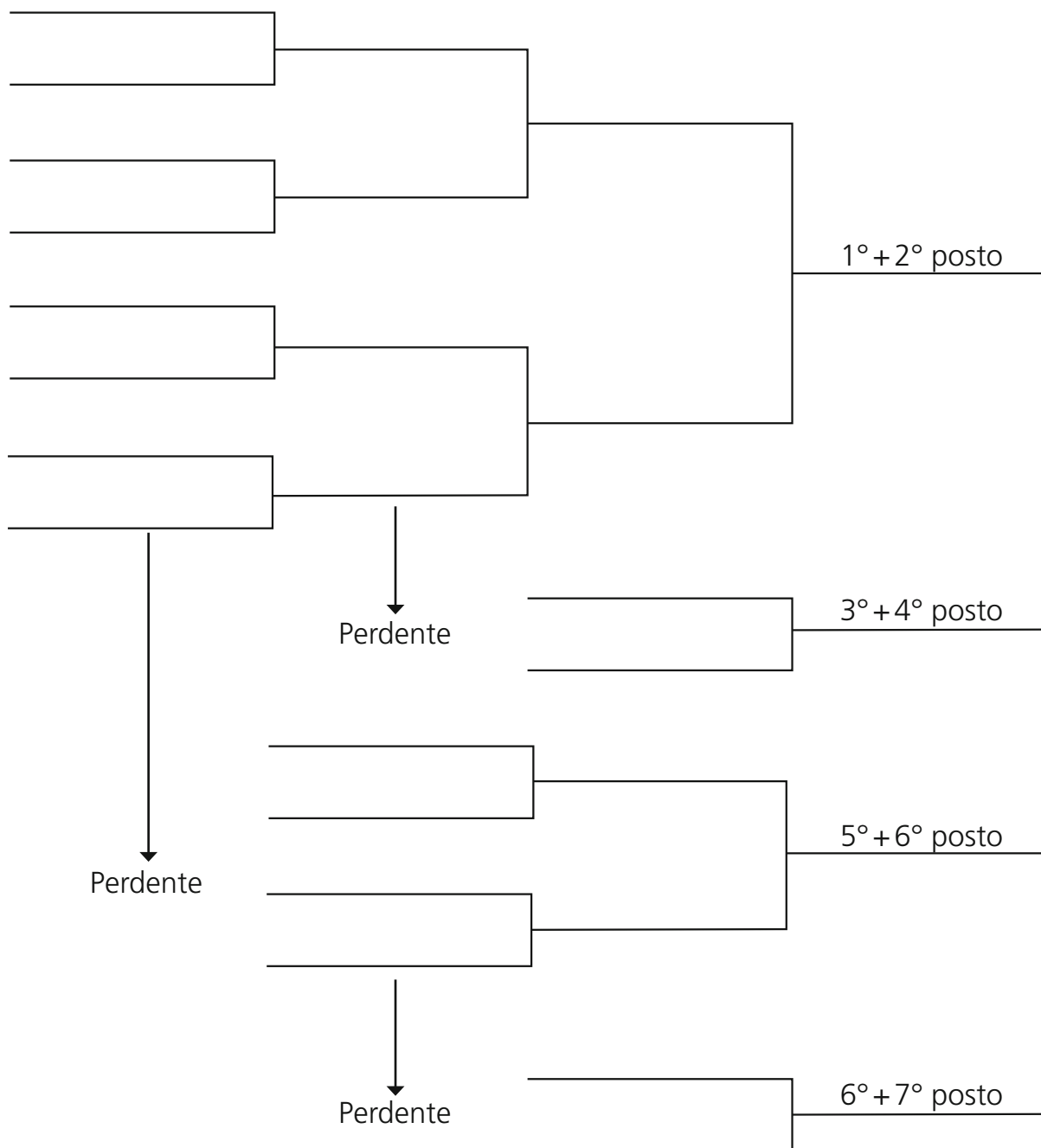



## Torneo con classifica

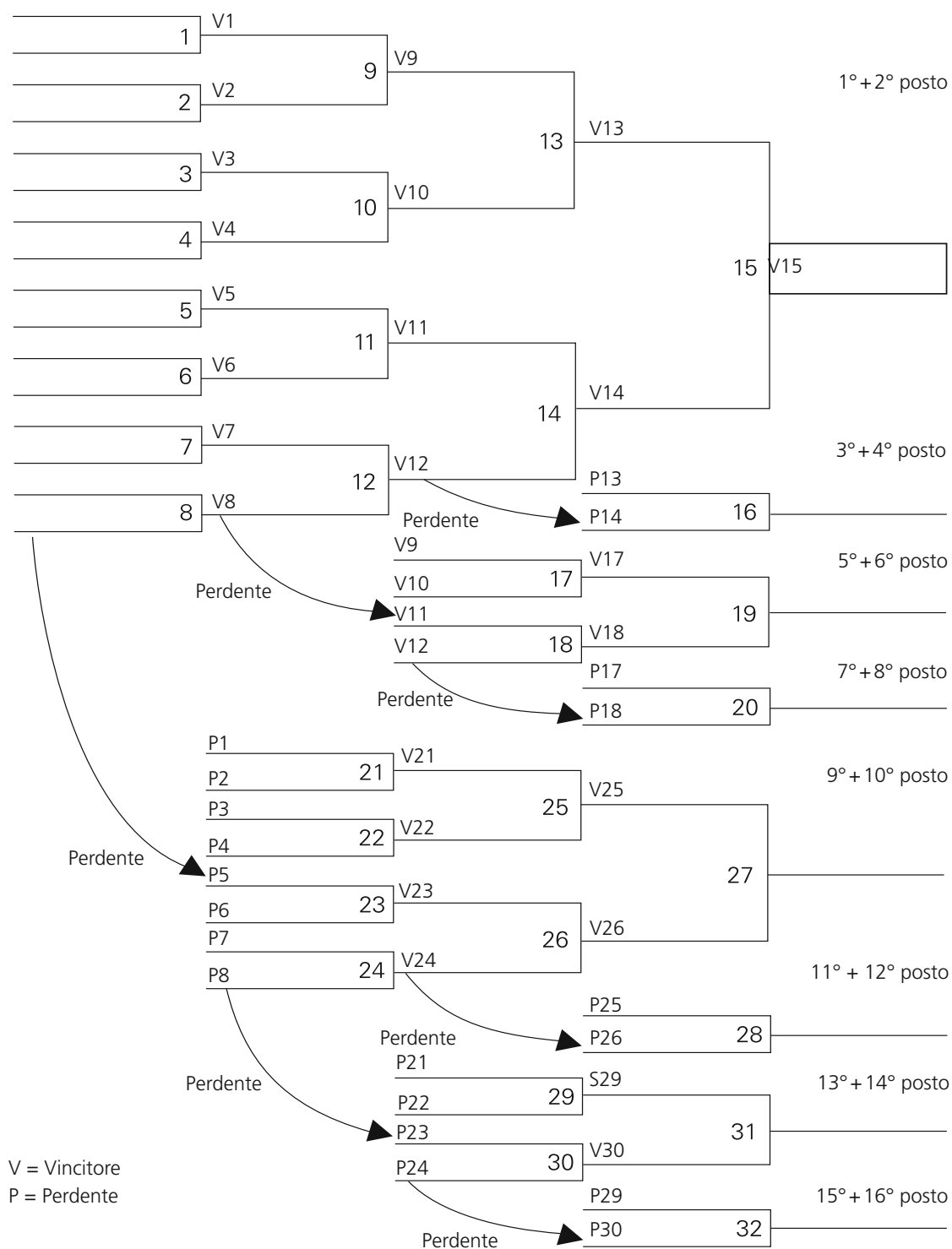



## Torneo con classifica

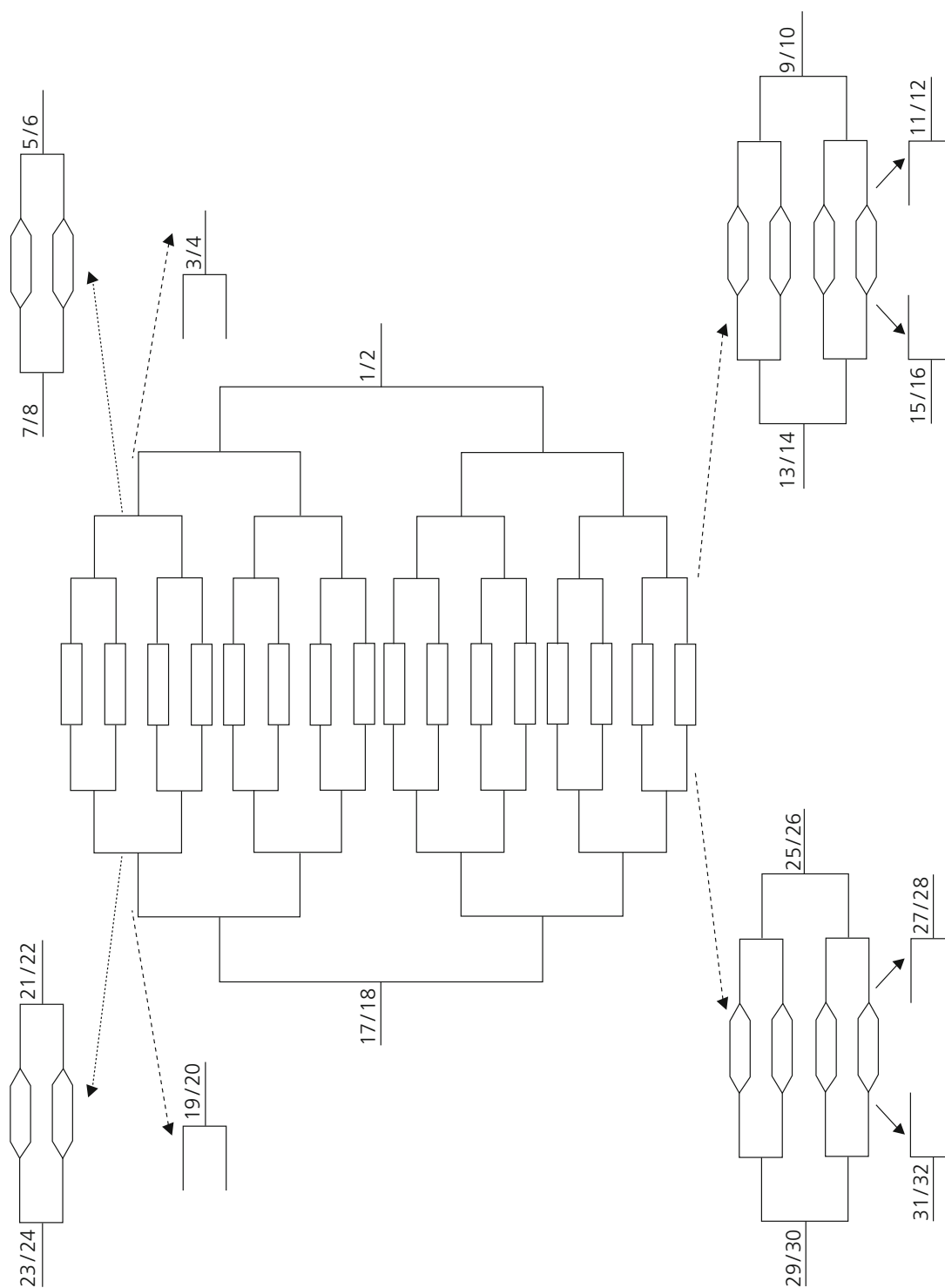





## Torneo con pool eliminatoria

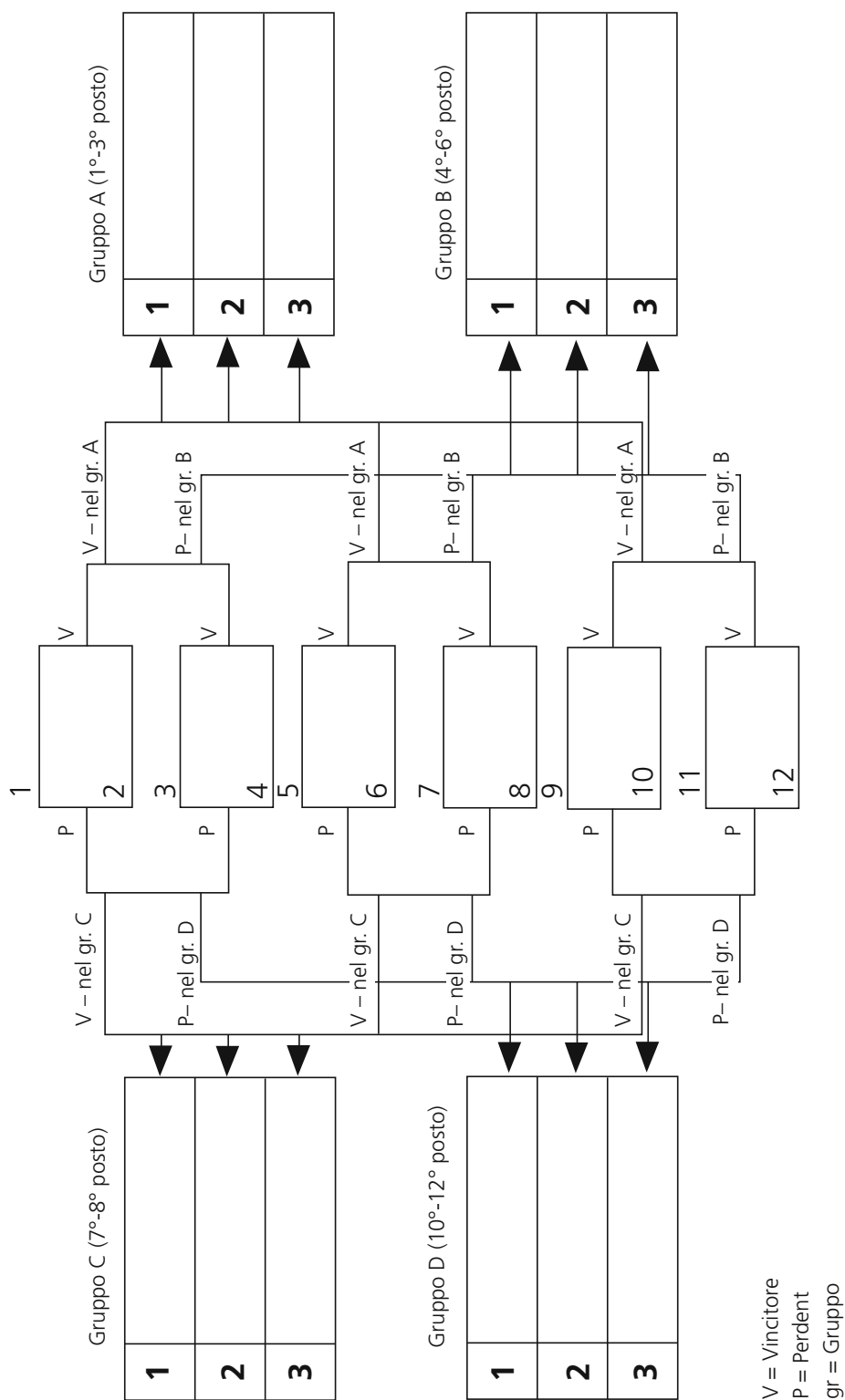



## Torneo con pool eliminatoria

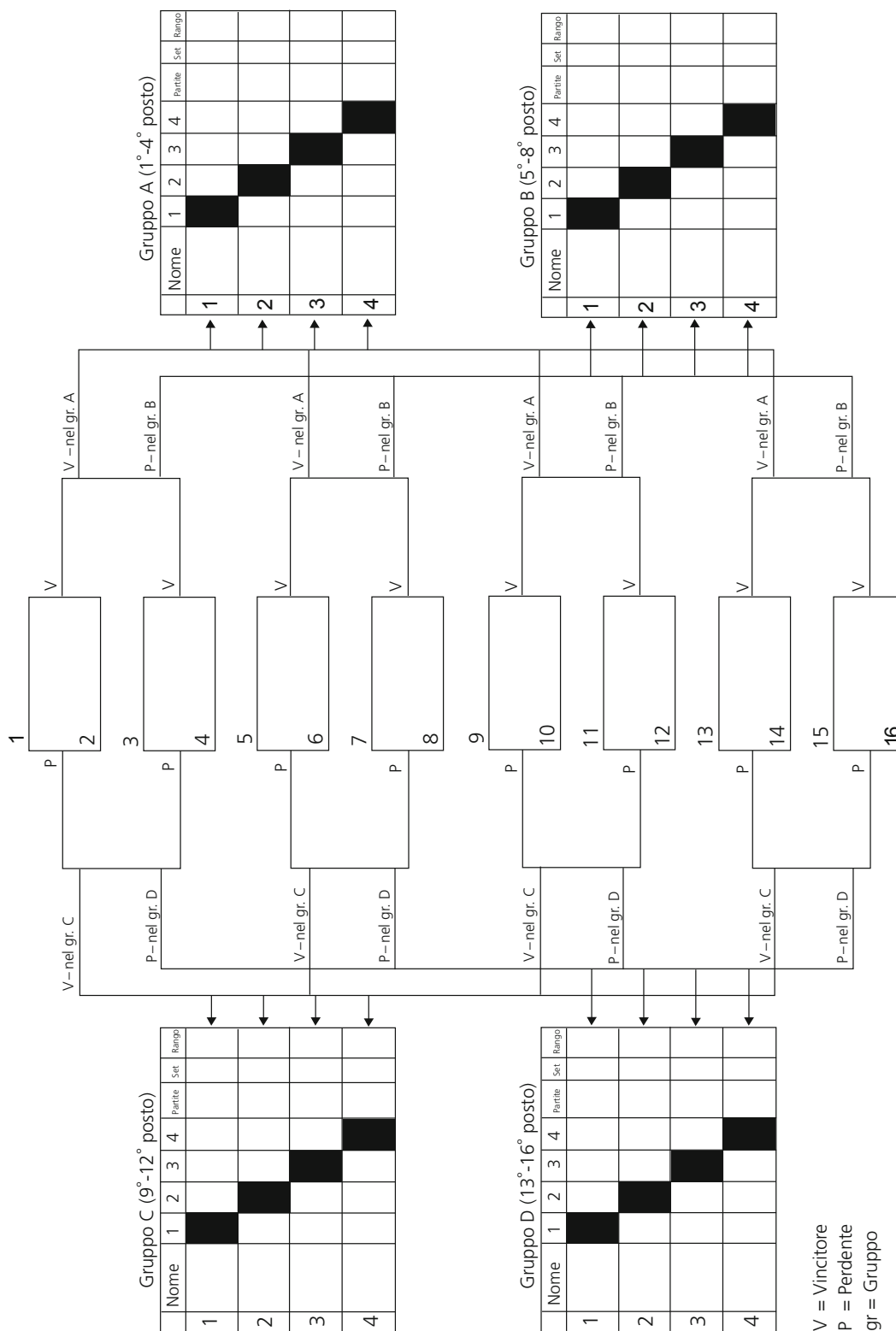



## Torneo a eliminazione a gruppi

Gruppo B

	Nome	1	2	3	4	5	Partite	Set	Rango
1		■							
2			■						
3				■					
4					■				
5						■			

Gruppo A

	Nome	1	2	3	4	Partite	Set	Rango
1		■						
2			■					
3				■				
4					■			

A1 = 1° del gruppo A  
B2 = 2° del gruppo B  
V = Vincitore  
P = Perdente

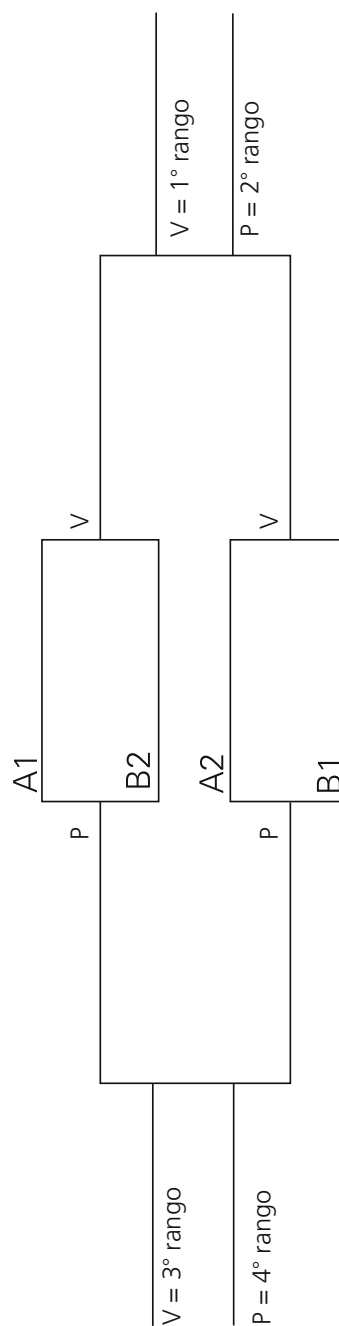



## Torneo a eliminazione a gruppi

Gruppo A

	Nome	1	2	3	4	Partite	Set	Rango
1		■						
2			■					
3				■				
4					■			

Gruppo B

	Nome	1	2	3	4	Partite	Set	Rango
1		■						
2			■					
3				■				
4					■			

Gruppo C

	Nome	1	2	3	4	Partite	Set	Rango
1		■						
2			■					
3				■				
4					■			

Gruppo D

	Nome	1	2	3	4	Partite	Set	Rango
1		■						
2			■					
3				■				
4					■			

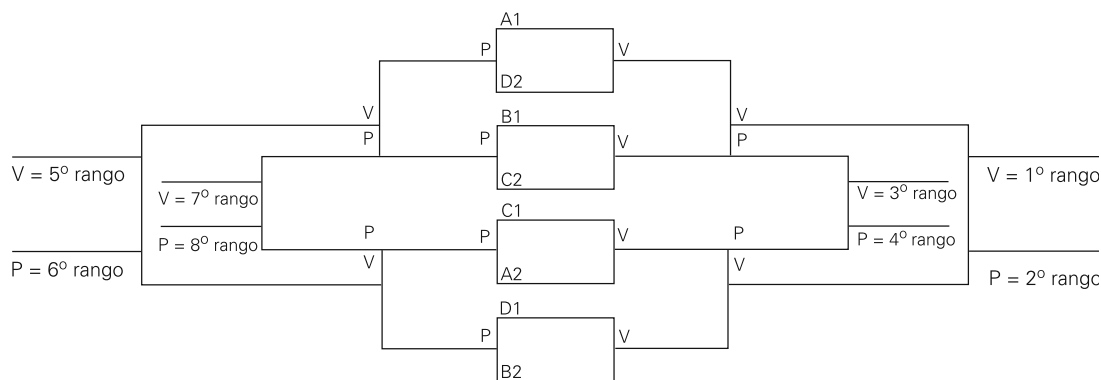

A1 = 1° del gruppo A

B2 = 2° del gruppo B

V = Vincitore

P = Perdente

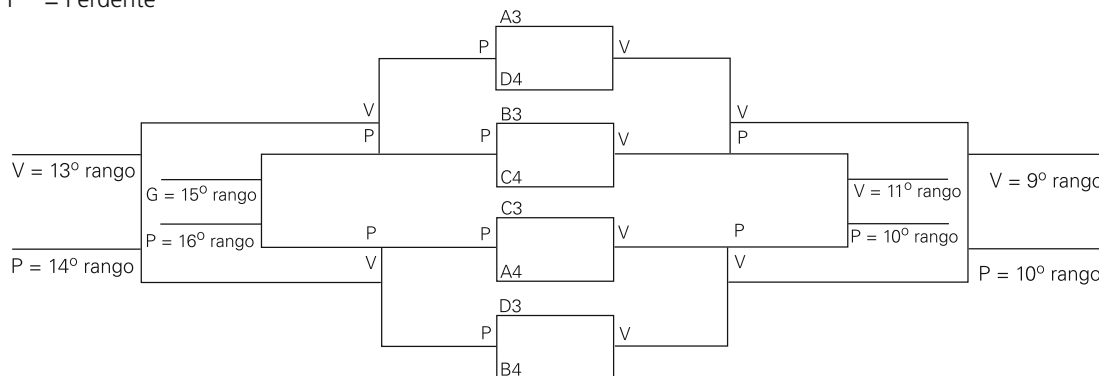



## Torneo a cassette

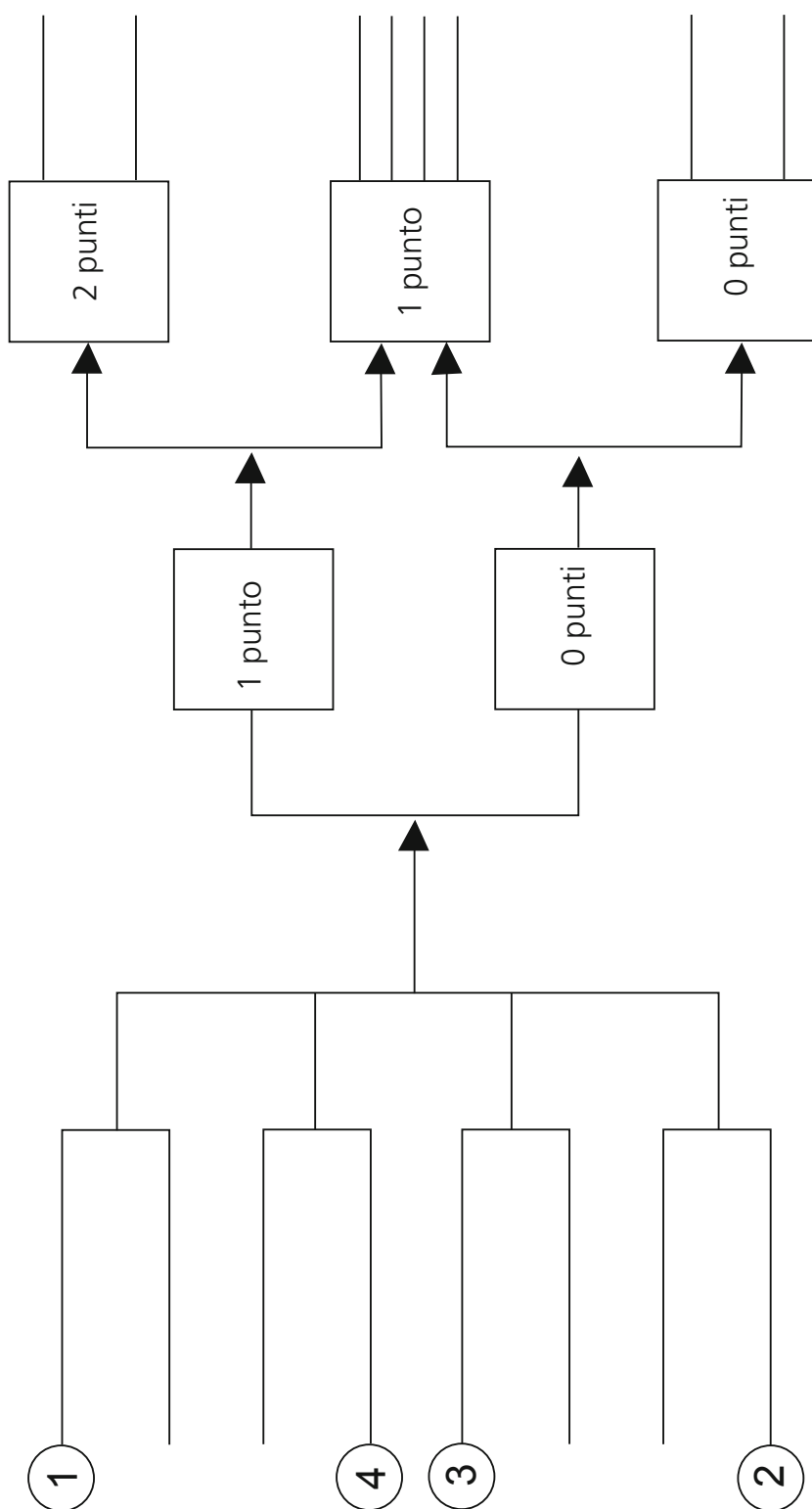



## Torneo a cassette

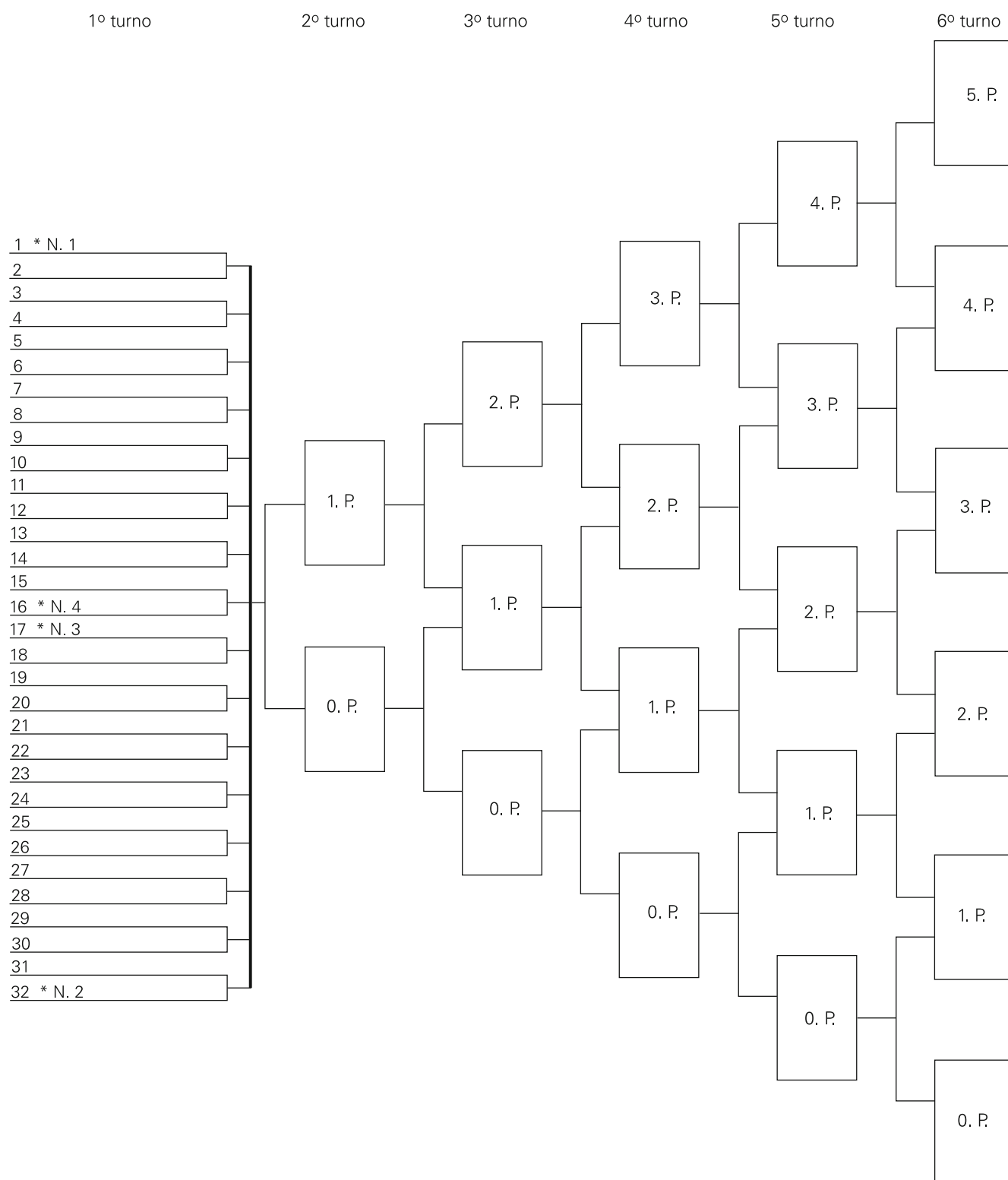

## Tutti contro tutti

Piano di gioco		4/2			
A	B	1	2	3	4
1-2	3-4				
4-3	2-1				
4-2	3-1				
1-3	2-4				
2-3	1-4				
4-1	3-2				
<b>Totale</b>					

Piano per 4 squadre (1-4) con 2 campi (A-B)





## Tutti contro tutti

Piano di gioco		5/2				
A	B	1	2	3	4	5
4-2	3-1					
3-2	5-4					
1-4	2-5					
5-3	2-1					
1-5	4-3					
Totale						

Piano per 5 squadre (1-5) con 2 campi (A-B)





## Tutti contro tutti

Piano di gioco		6/2					
A	B	1	2	3	4	5	6
2-4	1-3						
3-5	4-6						
1-4	5-2						
6-3	2-1						
3-2	4-5						
5-6	4-3						
5-1	2-6						
6-1							
<b>Totale</b>							

Piano per 6 squadre (1-6) con 2 campi (A-B)

## Tutti contro tutti

Piano di gioco		6/3						
A	B	C	1	2	3	4	5	6
3-1	2-4	6-5						
4-6	5-3	1-2						
3-2	6-1	5-4						
5-2	1-4	3-6						
1-5	2-6	4-3						
Totale								

Piano per 6 squadre (1-6) con 3 campi (A-C)



## Tutti contro tutti

Piano di gioco								7/3	
A	B	C	1	2	3	4	5	6	7
1-6	2-5	3-4							
7-5	1-4	2-3							
6-4	7-3	1-2							
5-3	6-2	7-1							
4-2	5-1	6-7							
3-1	4-7	5-6							
2-7	3-6	4-5							
Totale									

Piano per 7 squadre (1-7) con 3 campi (A-C)



## Tutti contro tutti

Piano di gioco										8/3
A	B	C	1	2	3	4	5	6	7	8
1-8	2-6	3-5								
	5-1	4-2								
7-6	4-8	1-3								
6-5	3-7	8-2								
2-3	5-4	7-1								
5-8	3-6	1-4								
4-7	2-5	8-6								
1-2	8-3	7-5								
4-3	6-1	7-2								
	8-7	4-6								
<b>Totale</b>										

Piano per 8 squadre (1-8) con 3 campi (A-C)



## Tutti contro tutti

Piano di gioco										8/4	
A	B	C	D	1	2	3	4	5	6	7	8
1-8	2-7	3-6	5-4								
7-8	6-1	5-2	4-3								
3-2	8-5	1-4	6-7								
5-6	7-4	8-3	2-1								
3-7	2-6	8-4	1-5								
4-2	5-3	7-1	6-8								
4-6	1-3	7-5	2-8								
<b>Totale</b>											

Piano per 8 squadre (1-8) con 4 campi (A-D)



## Tutti contro tutti

Piano di gioco										9/4		
A	B	C	D	1	2	3	4	5	6	7	8	9
1-8	2-7	3-6	4-5									
9-7	1-6	2-5	3-4									
8-6	9-5	1-4	2-3									
7-5	8-4	9-3	1-2									
6-4	7-3	8-2	9-1									
5-3	6-2	7-1	8-9									
4-2	5-1	6-9	7-8									
3-1	4-9	5-8	6-7									
2-9	3-8	4-7	5-6									
Totale												

Piano per 9 squadre (1-9) con 4 campi (A-D)





## Tutti contro tutti

Piano di gioco											10/5			
A	B	C	D	E	1	2	3	4	5	6	7	8	9	10
	6 : 3 x		7 : 3 x	10 : 3 x										
10-1	7-4	6-5	9-2	8-3										
7-2	6-3	5-4	8-1	10-9										
4-3	5-2	10-8	7-9	6-1										
9-4	8-5	7-6	1-3	10-2										
3-9	10-6	2-1	5-7	4-8										
10-5	2-8	1-9	4-6	3-7										
2-6	1-7	9-8	3-5	10-4										
8-7	9-6	10-3	2-4	1-5										
6-8	4-1	3-2	10-7	5-9										
Totale														

Piano per 10 squadre (1-10) con 4 campi (A-E)



## Tutti contro tutti

Piano di gioco											11/5				
A	B	C	D	E	1	2	3	4	5	6	7	8	9	10	11
1-10	2-9	3-8	4-7	5-6											
11-9	1-8	2-7	3-6	4-5											
10-8	11-7	1-6	2-5	3-4											
9-7	10-6	11-5	1-4	2-3											
8-6	9-5	10-4	11-3	1-2											
7-5	8-4	9-3	10-2	11-1											
6-4	7-3	8-2	9-1	10-11											
5-3	6-2	7-1	8-11	9-10											
1-2	5-1	6-11	7-10	8-9											
3-1	4-11	5-10	6-9	7-8											
2-11	3-10	4-9	5-8	6-7											
Totale															

Piano per 11 squadre (1-11) con 5 campi (A-E)







## Tutti contro tutti

		Piano di gioco																	
		13/6																	
A	B	C	D	E	F	1	2	3	4	5	6	7	8	9	10	11	12	13	
1-12	2-11	3-10	4-9	5-8	6-7														
13-11	1-10	2-9	3-8	4-7	5-6														
12-10	13-9	1-8	2-7	3-6	4-5														
11-9	12-8	13-7	1-6	2-5	3-4														
10-8	11-7	12-6	13-5	1-4	2-3														
9-7	10-6	11-5	12-4	13-3	1-2														
8-6	9-5	10-4	11-3	12-2	13-1														
7-5	8-4	9-3	10-2	11-1	12-13														
6-4	7-3	8-2	9-1	10-13	11-12														
5-3	6-2	7-1	8-13	9-12	10-11														
4-2	5-1	6-13	7-12	8-11	9-10														
3-1	4-13	5-12	6-11	7-10	8-9														
2-13	3-12	4-11	5-10	6-9	7-8														
<b>Totale</b>																			

Piano per 13 squadre (1-13) con 6 campi (A-F)



## Torneo a estrazione

Partite vinte      2 punti  
Partite pareggiate   1 punto  
Partite perse      0 punti

Nome:	Rango:	<input type="text"/>
-------	--------	----------------------

	Risultato	Punti
1° turno	:	
2° turno	:	
3° turno	:	
4° turno	:	
5° turno	:	
6° turno	:	
7° turno	:	
8° turno	:	
9° turno	:	
10° turno	:	
Differenza: <input type="text"/>	Totale: :	



## Coppa Davis

Squadra A	Giocatore	Squadra B	Giocatore	Risultato	Punti
1° singolare		1° singolare			
2° singolare		2° singolare			
1° doppio		1° doppio			
Risultato dell'incontro					